

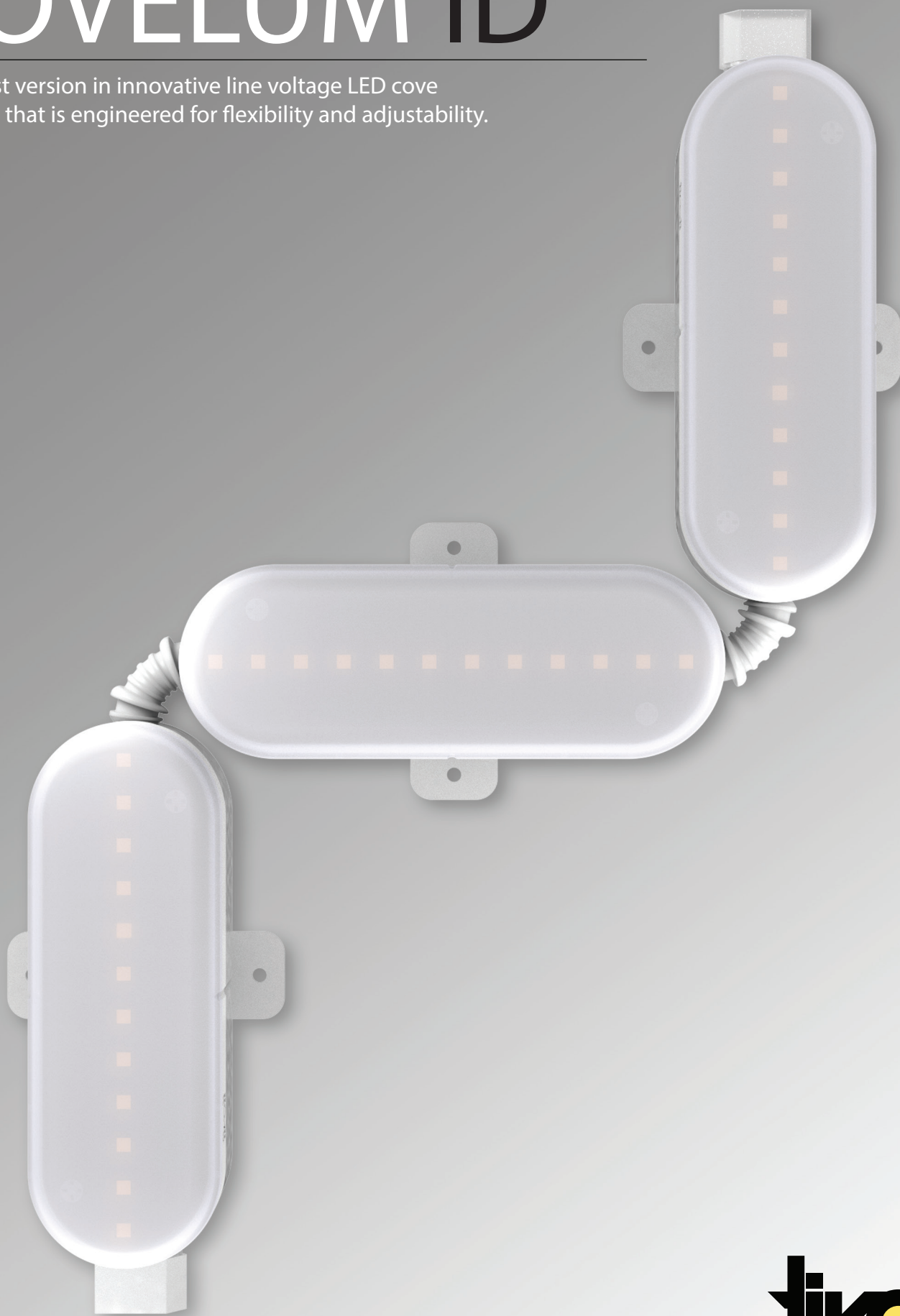



COVELUM ID





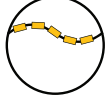

The latest version in innovative line voltage LED cove solution, that is engineered for flexibility and adjustability.



tivoli



				
5.6W/Set 376LM/Set	IP54	Flexible	120V	Warranty

					
2200K	2500K	2700K	3000K	3500K	4000K

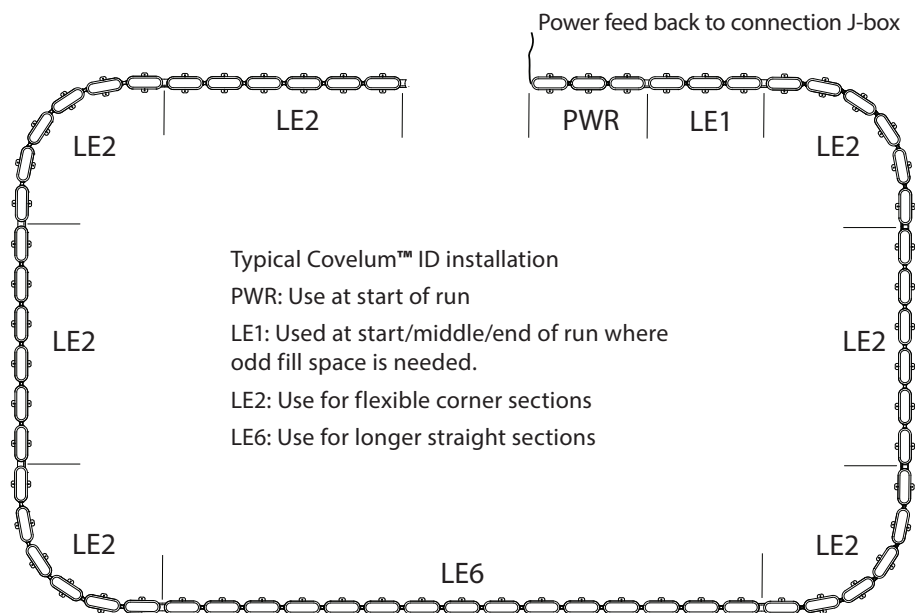

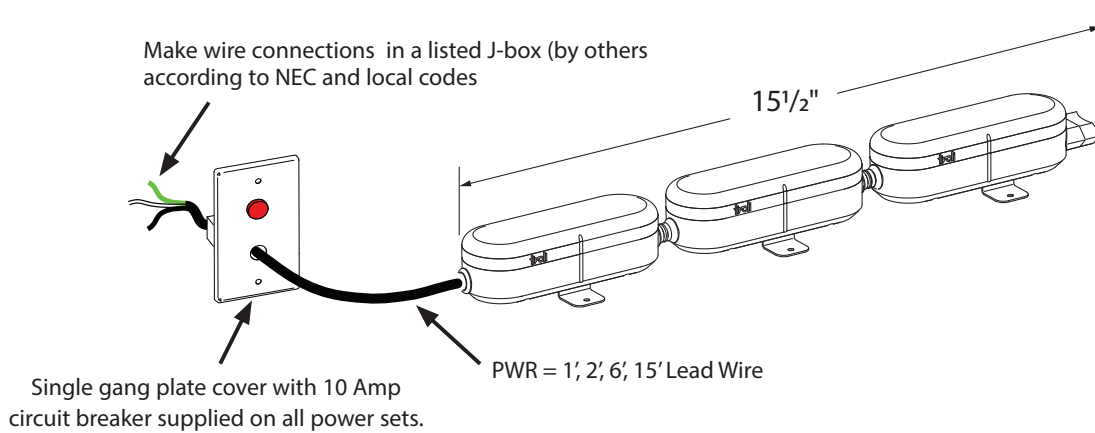
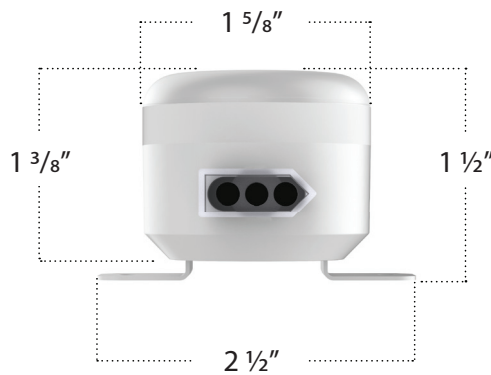
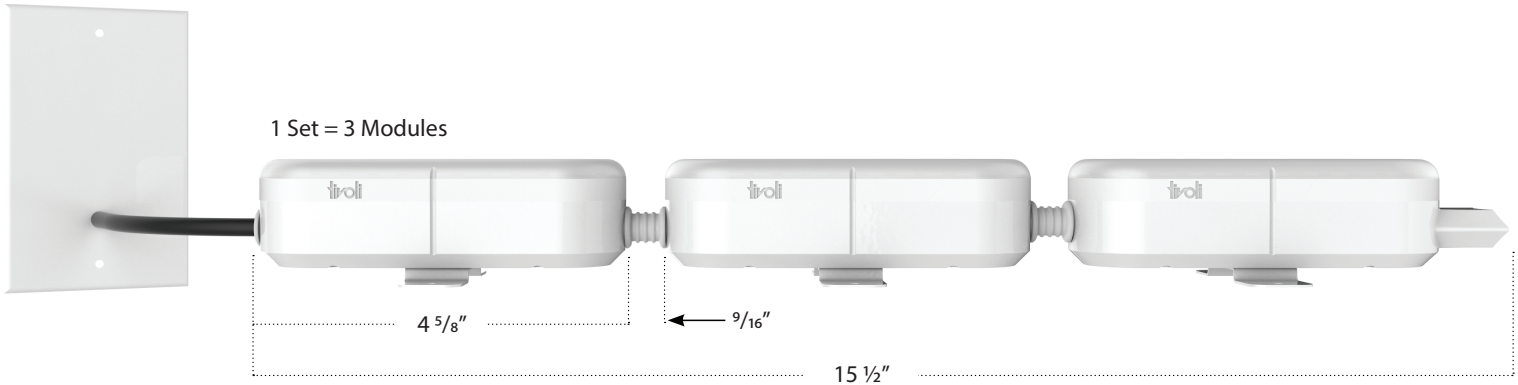

Power Set Order Guide

NOTE:
System must have one (PWR) Power Set at start of each circuit run length.

*Consult Factory for 277V applications

PRODUCT CODE	LED COLOR	PREP	VOLTAGE
CVLID Covelum™ ID	22 = 2200K 25 = 2500K 27 = 2700K 30 = 3000K 35 = 3500K 40 = 4000K	PWR1= Power Set, 1' NOM, 1' lead wire PWR2= Power Set, 1' NOM, 2' lead wire PWR6= Power Set, 1' NOM, 6' lead wire PWR15= Power Set, 1' NOM, 15' lead wire	120 120 = 120V

1 Set = 3 Modules

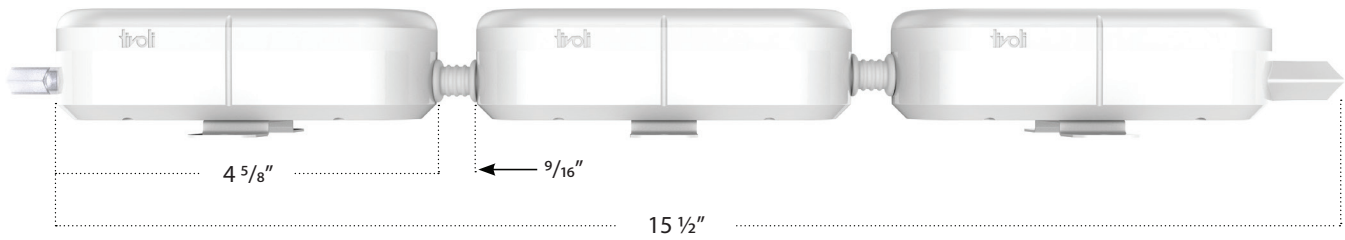

LE1 Light Extension Set, 1' NOM
(1 Set)

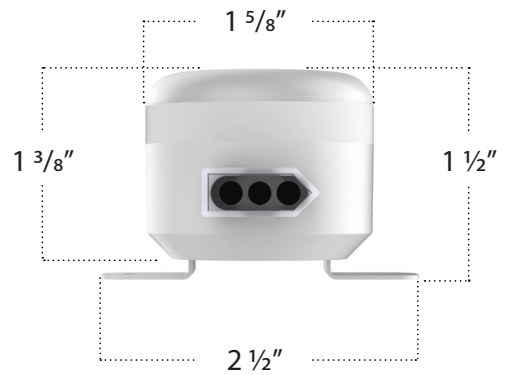
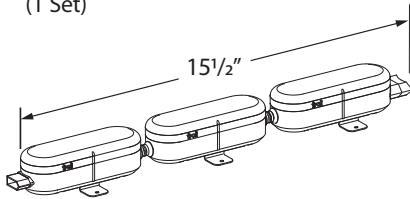

LE2 Light Extension Set, 2' NOM
(2 Set)

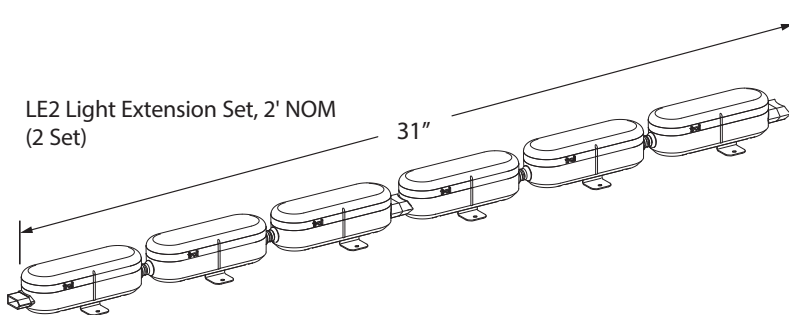

LE6 Light Extension Set, 6' NOM
(5 Set)

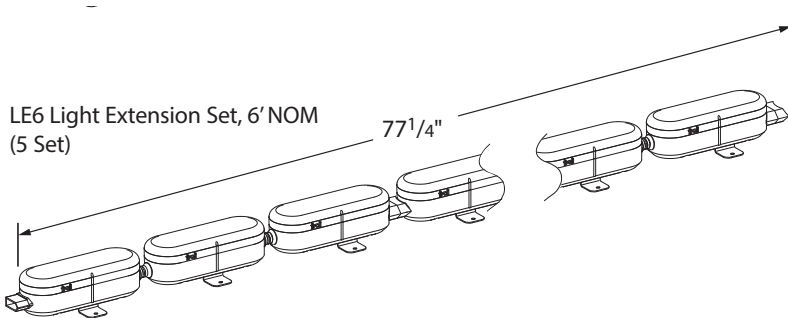

Light Extension Set Order Guide

NOTE:

Light Extension Sets (LE) are flexible and have integral connections on both ends for easy run length connection.

PRODUCT CODE	LED COLOR	PREP	VOLTAGE
CVLID Covelum™ ID	22 = 2200K 25 = 2500K 27 = 2700K 30 = 3000K 35 = 3500K 40 = 4000K	LE1 = 1' NOM light extension (15.5") 1 set LE2 = 2' NOM light extension (31") 2 set LE6 = 6' NOM light extension (77.25") 5 set	120 120 = 120V

Mounting Information

Swivel Mounting Feet

All Covelum™ ID modules include integrated swivel mounting feet. Each unit can be mounted in various positions and swivel mounting feet can be bent to allow angled surface applications.

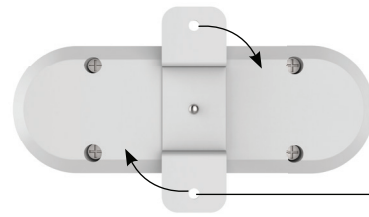

SWIVEL MOUNTING FEET
Hole Size 1/8"

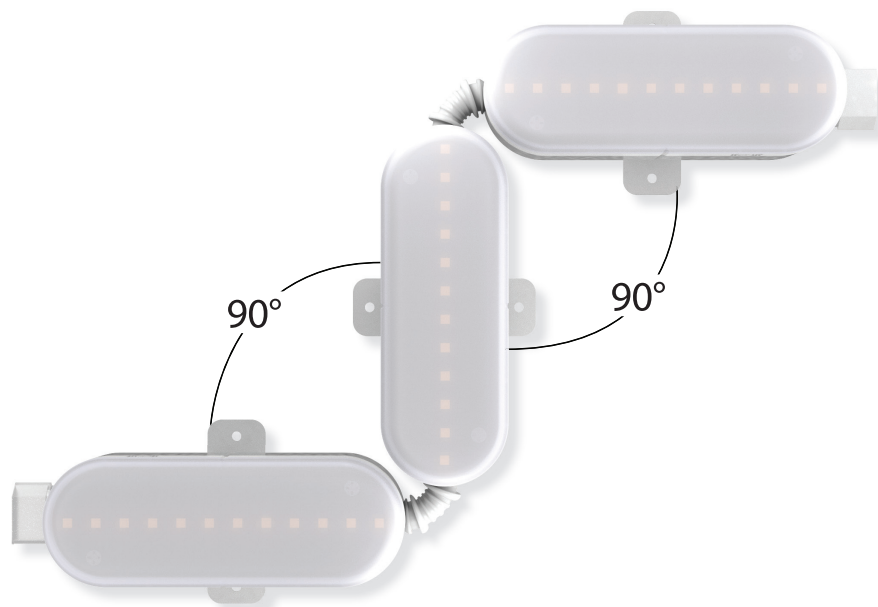
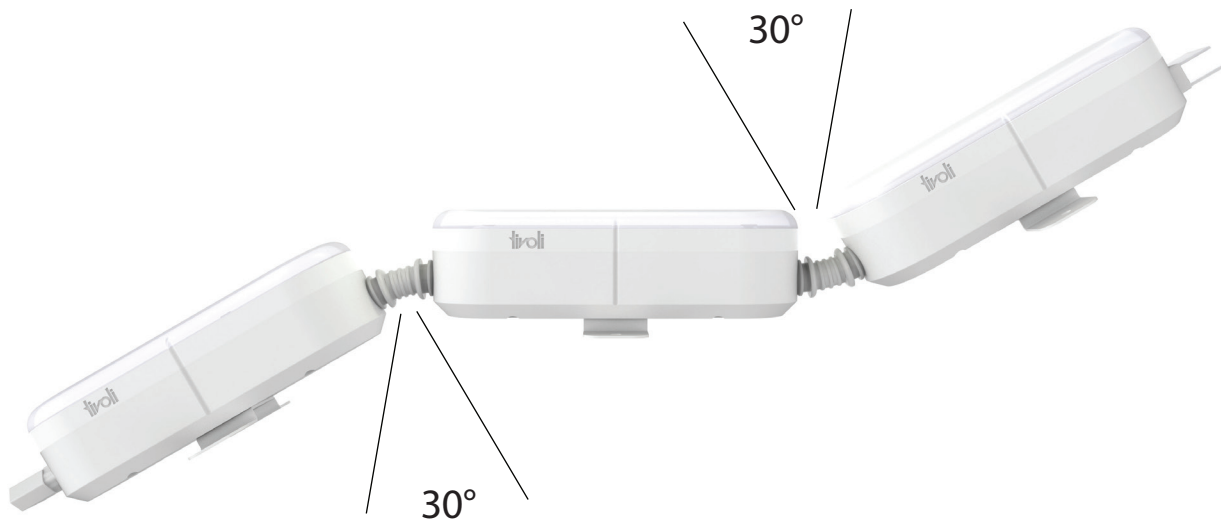

Replacement Parts



***DESIGNER MODEL PCB**
CVLID-PCB-22
 2200K
CVLID-PCB-25
 2500K
CVLID-PCB-27
 2700K
CVLID-PCB-30
 3000K
CVLID-PCB-35
 3500K
CVLID-PCB-40
 4000K



REPLACEMENT LENS
CVLID-LENS-F
 Frosted Lens (1PC)



REPLACEMENT LENS
CVLID-LENS-C
 Clear Lens (1PC)



MOLEX JUMPER CABLES
CVL120-JUMPER-1
 Male/Female - 1' length
CVL120-JUMPER-2
 Male/Female - 2' length
CVL120-JUMPER-4
 Male/Female - 4' length
CVL120-JUMPER-8
 Male/Female - 8' length

Recommended Dimmers

DIMMING - MLV

DESCRIPTION	CAT NO	APPLICATION	INPUT VOLTAGE	OUTPUT VOLTAGE	MAX LOAD
MLV Dimmer	N-600	Indoor	120V AC	120V AC	450W

IESNA TM-30-15

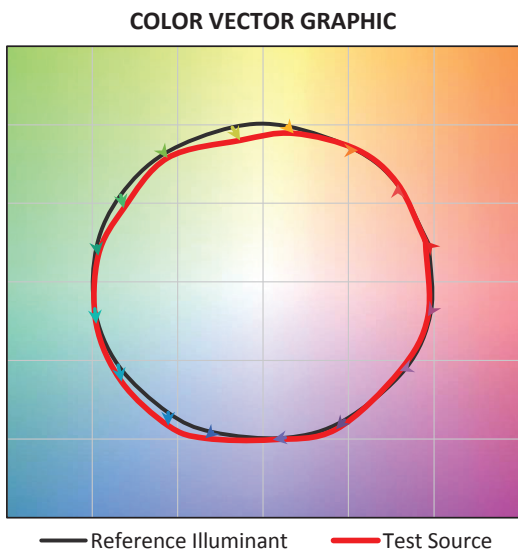
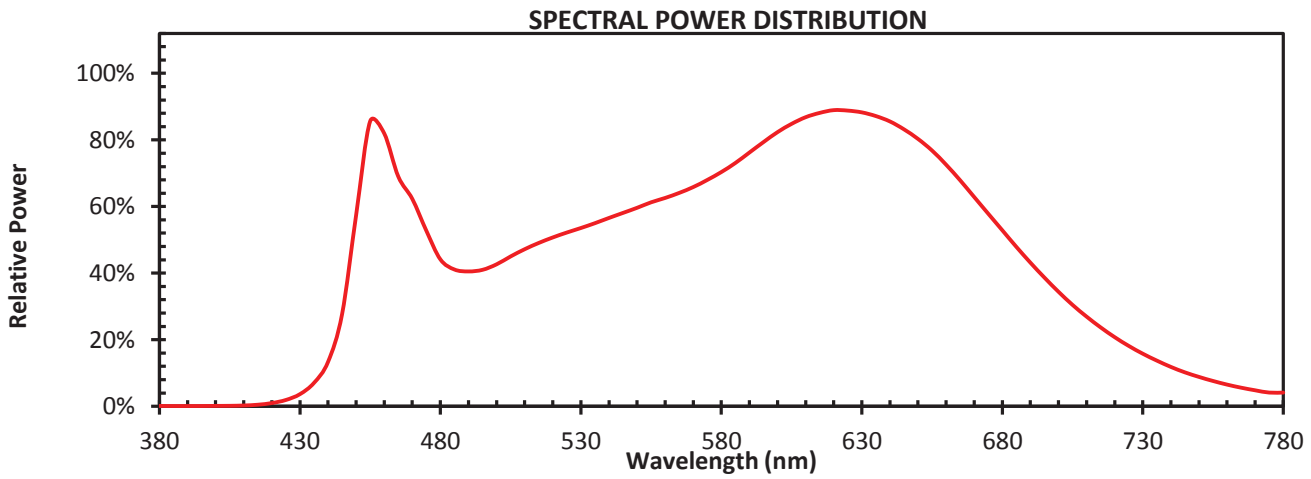

HUE BIN	R_f	CHROMA % SHIFTS	HUE % SHIFTS
1	90	-2%	3%
2	93	0%	1%
3	95	1%	-1%
4	88	-4%	-5%
5	87	-9%	-3%
6	93	-3%	0%
7	86	-6%	6%
8	89	-2%	6%
9	84	1%	10%
10	83	4%	10%
11	86	7%	5%
12	88	5%	-3%
13	89	0%	-7%
14	88	2%	-7%
15	87	-2%	-3%
16	86	-1%	-3%

IESNA TM-30-15

Hue Angle Bin vs. Fidelity Index

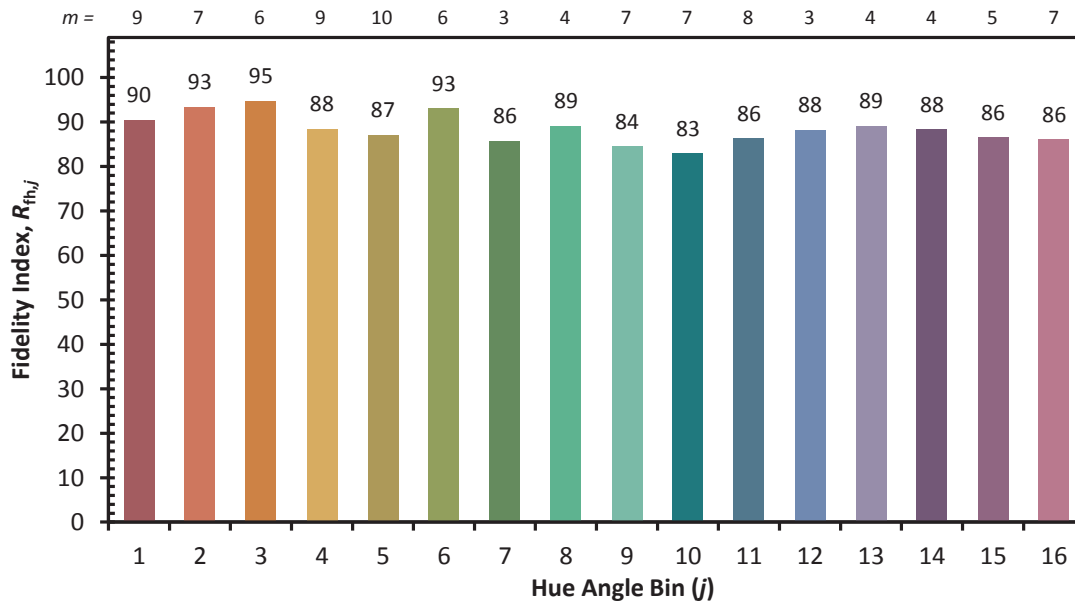

Hue Angle Bin vs. Change of Chroma

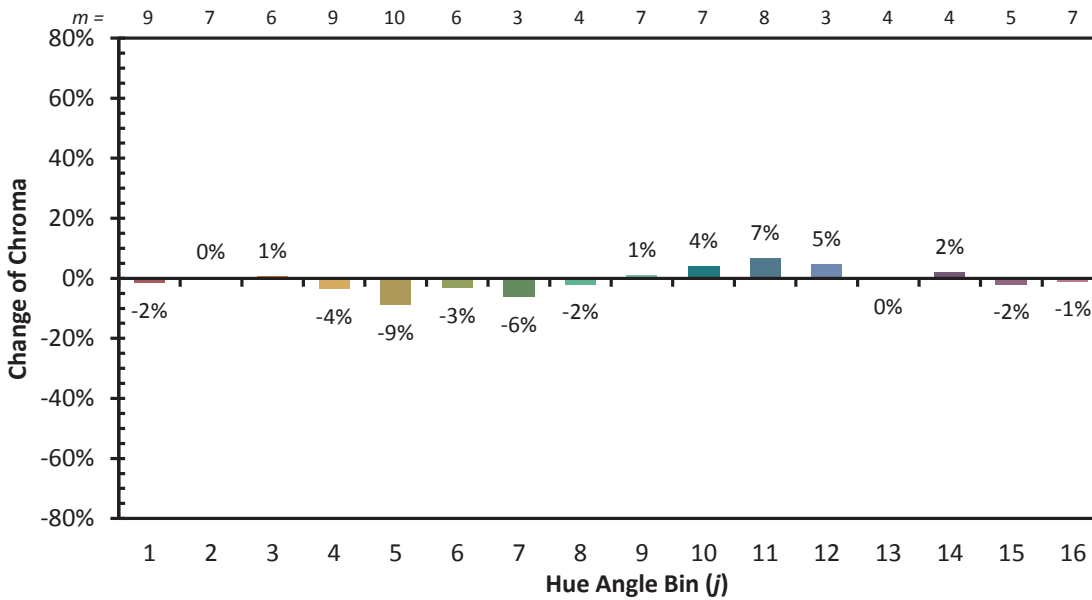

Photometric Data (Based on 3500K / (1) Power Set @ (3) Modules)

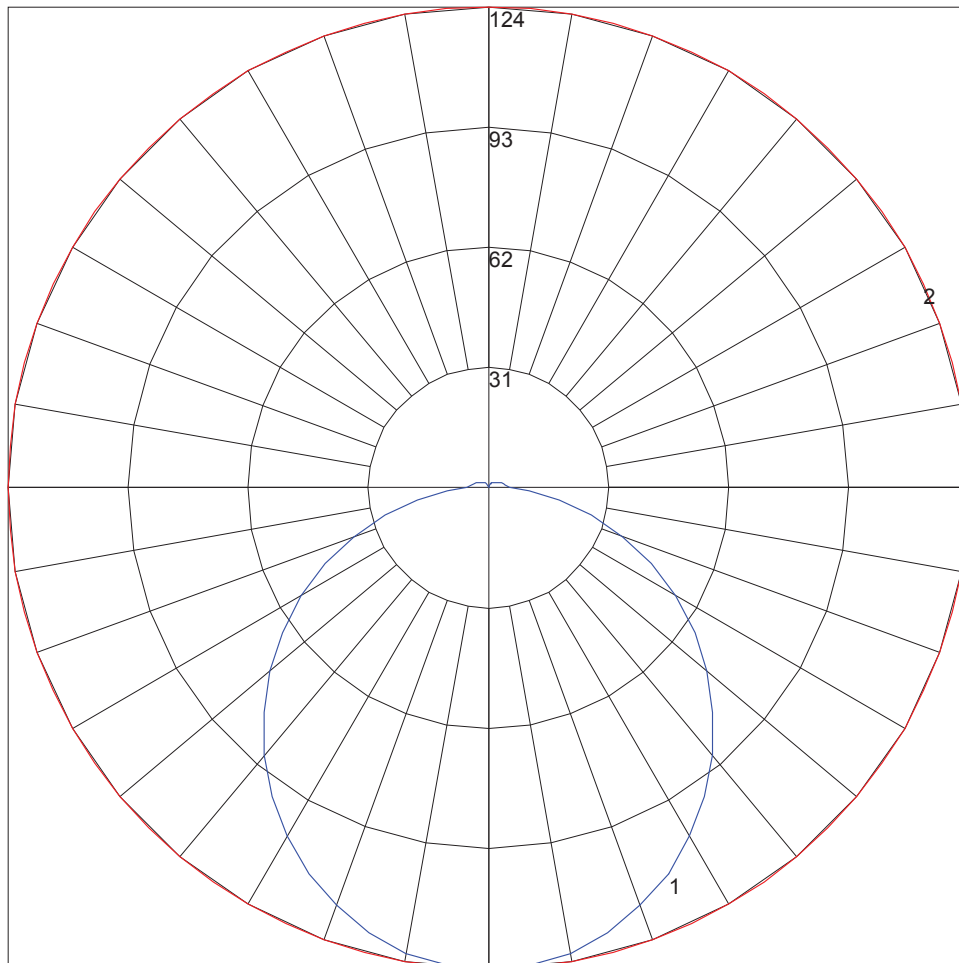

Maximum Candela = 124.17
Located At Horizontal Angle = 0
Vertical Angle = 0
#1 Vertical Plane Through Horizontal Angles (0-180) (Through Max. Cd.)
#2 Vertical Cone Through Vertical Angle (0) (Through Max. Cd.)

Electrical & Photometric Data (Based on 3500K / (1) Power Set @ (3) Modules)						
Input Voltage	120V AC					
Dimming Option	Triac					
Power Consumption	5.55 W/Set					
Power Factor (PF)	0.8					
Color Temperature (CCT)	2200K	2500K	2700K	3000K	3500K	4000K
Lumen Output/Set	332	346	353	363	375	411
Efficacy/Set	60	63	64	66	68	75
Color Rendering Index (CRI)	93					
R9	94.64					
TM-30-15 Fidelity Index (R_f)	88					
TM-30-15 Gamut Index (R_g)	98					

Physical	
PCB O.C. Spacing (Average)	23/64"
LEDs/Module	12
Operating Temperature	-40°F (-40°C) ~ +140°F (+60°C)
Environment	IP54 (Protected from limited dust ingress & water spray)
Maximum Run Length (Non-Dim)	185'
Maximum Run Length (Dimmable)	132' (Based on 1.1% lumen drop at full brightness, 10% at full dimmed)
Order Increment	15.5", 31", 77.25"

Performance	
Certification	ETL Listed
Lumen Maintenance (L70) Hours	60,000
Warranty	5 Years